

MISA

SKOPE MISA Cool & Freezer Rooms



CONTACT SKOPE

SKOPE INDUSTRIES LIMITED

A.B.N. 73 374 418 306
PO Box 7543, Baulkham Hills B.C.
NSW 2153, Australia
Freephone: 1800 121 535
Fax: 1800 121 533
E-mail: misa@skope.co.nz
Website: www.skope.com



INSTALLATION & WARRANTY

For installation and warranty enquiries please call SKOPE on 1800 121 535

MISA
SKOPE MISA Cool & Freezer Rooms

Installation Manual

MAN10745
Rev. 6.0 Apr. 2015

© 2013 SKOPE Industries Limited. All rights reserved.
SKOPE Industries Limited reserve the right to alter specifications without notice.

SKOPE is a registered trademark of SKOPE Industries Limited

CONTENTS

1 Specifications	
2 Commissioning	
Installation Guidelines	6
3 Preparation	
Positioning the Room	9
Unpacking	10
Parts	11
4 Installation	
Tools and Materials Required	12
Fitting Parts Together	13
Room Installation.	14
Freeblock Refrigeration Unit	20
Freeblock Control Panel	23
Electrics.	25
Door Switch.	27
Room Inspection	30
Drop-In Refrigeration Unit.	31
5 Servicing	
Cleaning	32
Door.	32

1 Specifications

Compliance SKOPE Industries Limited MISA cool and freezer rooms comply with the Australian and New Zealand building code, the Australian Food Safety Standard 3.2.3 (food premises and equipment) and the Australian Standard AS 4674-2004 (design, construction and fitout of food premises).

Modular Construction Rooms

Insulation	100mm polyurethane foam
Door/s	Self-closing, solid foamed swing door

Dimensions

Model	Internal volume (m ³)	Freeblock unit	External dimensions (mm)		
			Width	Depth	Height*
KLC1AF2M	3.07	FB 3G	1430	1430	2230
KLC2AF2M	4.06	FB 3G	1430	1830	2230
KLC3BF2M	6.71	FB 13G	1830	2230	2230
KLC3CF2M	8.37	FB 13G	2230	2230	2230
KLC4CF2M	10.05	FB 16G	2630	2230	2230
KLC4DF2M	11.99	FB 16G	2630	2630	2230
KLC5DF2M	13.95	FB 20G	3030	2630	2230
KLC5EF2M	16.25	FB 20G	3030	3030	2230
KLC6EF2M	18.56	FB 26G	3430	3030	2230

*Internal height 2m, also available in 2.4m

MISA Freeblock Technical specifications

Model	Temp. range (°C)	Supply (Volts)	32°C Ambient		43°C Ambient	
			Nominal capacity (Watts)	Current draw (Amps)	Nominal capacity (Watts)	Current draw (Amps)*
FB 3G	-2 to +2	230	1140	2.7	950	2.7
FB 7G		230	1140	2.7	950	2.7
FB 13G		230	1520	2.9	1220	2.9
FB 16G		230	2020	4.9	1670	4.9
FB 20G		415 (3 phase)	2470	2.2	2040	2.2
FB 26G		415 (3 phase)	3130	2.5	2530	2.5
FB 3N	-18 to -20	230	770	2.7	700	2.7
FB 5N		230	770	2.7	700	2.7
FB 6N		230	960	3.1	865	3.1
FB 13N		230	1320	4.8	1160	4.8
FB 20N		415 (3 phase)	1830	2.3	1560	2.3
FB 28N		415 (3 phase)	2800	4.1	2375	4.1

* Excludes door heater current draw of 2 Amps

MISA Drop-In Technical specifications**

Model	Temp. range (°C)	Supply (Volts)	Nominal capacity (Watts)	Current draw (Amps)*
MB7SF	-5 to +10	230	1450	2.7
MB13SF		230	2080	2.7
MB16SF		230	2450	2.9
MB20SF		230	3270	4.9
MB26SF		230	4400	2.5
MB4NSF	-25 to -5	230	1190	2.7
MB9NSF		230	1690	2.7
MB15NSF		230	2480	4.1

* Excludes door heater current draw of 2 Amps

**Refer to the MISA Drop-In specification sheet (PSS0336) for detailed MISA Drop-In specifications.

2 Commissioning

Installation Guidelines

Registration MISA cool rooms, freezer rooms and drop-in refrigeration units must only be installed by an approved SKOPE registered installer.

To register, the installer must complete the SKOPE online registration form, available on the SKOPE website - www.skope.com.

SKOPE will confirm if the installer is approved as a SKOPE registered installer for MISA products.

Compliance The installer must follow the installation guidelines as set out in this MISA installation manual for the construction of MISA Cool and Freezer rooms.

All cool room panels and equipment supplied by SKOPE must be installed in accordance with all relevant laws, regulations, building codes and standards ("Building Codes"). SKOPE may provide information regarding aspects of the Building Codes but this is provided as general information only and does not detract from the installer's responsibility to ensure that all equipment is installed in accordance with the Building Codes

The installer must check if the installation is within the tropical zone, which includes everywhere north of Byron Bay, Queensland. If the installation is within the tropical zone, the installer must consider the tropical environment which may require under floor heater wires or other additions.

The installer must ensure all electrical and refrigeration work is carried out by licensed technicians.

Ventilation The installer must ensure adequate heat extraction and ventilation is in place. If not in place the installer must advise the customer of requirements and advise to have ready and in place for installation.

The installer, not SKOPE, is responsible for ventilation of the refrigeration equipment.

Installation Installation must be completed in accordance with the MISA installation manual provided by SKOPE.

The installer must obtain an accurate MISA room plan from the customer prior to beginning an installation.

The installer must carry out a site inspection prior to confirmation of room order to ensure adequate ventilation of the refrigeration unit, and correct dimensions and placement of the room and refrigeration system.

Checklist After the room has been installed the installer must complete the MISA installation checklist found on the back page of this manual. A completed copy of the checklist must stay on site and a copy sent to SKOPE.

Warranty Subject to the conditions and exclusions set out in the SKOPE Warranty Terms (<http://www.skope.com/support/warranty>) and provided that the installation is completed by an approved SKOPE registered installer and in accordance with the installation guidelines set out in this MISA installation manual, SKOPE warrants that, for the period of two years commencing on

the date of purchase or 6 months from the date of manufacture (whichever is earlier), the MISA products will be free from any defect in workmanship or material. Where there is any conflict between this installation manual and the SKOPE Warranty Terms, the SKOPE Warranty Terms shall prevail.

SKOPE's sole obligation should the products be found upon inspection by or on behalf of SKOPE not to meet the warranty is to, at SKOPE's option, repair or replace the products without charge provided that the liability of SKOPE shall in no event exceed the purchase price of the products.

The application of any warranty provided by SKOPE for MISA products is expressly excluded where a defect, malfunction or failure of refrigeration equipment is due to inadequate ventilation, and the customer's recourse will be solely against the installer.

3 Preparation

Safety First Always observe safety precautions when using any electrical appliance. Read these instructions carefully and retain them for future reference.

- When the appliance is used by or near young children or infirm persons, close supervision is necessary, especially to ensure children do not play with it.
- Do **not** use this appliance for other than its intended use.
- Do **not** cover the grilles or block the entry or exhaust of airflow by placing objects up against the refrigeration unit.
- Do **not** close in or cover the refrigeration unit.
- Do **not** probe any opening.
- Only use this appliance with the voltage specified on the cabinet rating label.
- Ensure the appliance has adequate ventilation as this is essential to economical, high performance.
- Be careful not to touch moving parts and hot surfaces.
- For your own safety and that of others, ensure that all electrical work is done by authorised personnel.
- Ensure all necessary safety precautions are observed during installation or removal of the refrigeration unit.
- Do not store explosive substances such as aerosol cans with a flammable propellant in this appliance.
- Please contact SKOPE Customer Services for advice regarding disposal of this appliance.

WARNING

Always disconnect the refrigeration unit from the mains power supply before cleaning or maintenance.

CAUTION

Never overload the power supply, which could damage the appliance and product. See the rating label for the safe power supply and current draw.

CAUTION

There **must** be adequate ventilation and air flow around the Freeblock refrigeration unit.
 The ambient temperature around the condenser must not exceed 43°C.
 A poorly ventilated Freeblock refrigeration unit may overheat.
 Mechanical extraction of condenser air into ceiling space or preferably out of the building is advised.

See page 20 for Freeblock refrigeration unit safety and service guidelines.

Positioning the Room

Room Location Before assembling the room, decide where to position it. The room is installed from the inside so can be positioned in-place in tight spaces. Once installed, the room should not be moved.

We recommend that the room is installed in the coolest place possible. Do not install the refrigeration unit in direct sunlight. The ambient temperature around the Freeblock refrigeration unit must not exceed 43°C. Check manufacturers specifications if installing a third party refrigeration unit.

The room should be installed either away from walls to enable access for cleaning, or sealed to the walls to prevent harbourage of vermin. Enclosed areas above the room must be pest proofed.

Allow adequate space for the door to open and close properly. Self-closing swing doors are aligned and tensioned at the factory and must be unobstructed.

Refrigeration units must be supported well to allow for easy cleaning. Ensure adequate extraction or ventilation is available.

Prevent any noise nuisance to nearby residences and businesses. Refrigeration units should be placed away from neighbouring bedroom windows, office windows, multiple walls and corners.

Ensure the room sits on a level surface. There must be no more than 5mm difference between each end of the floor. Level flooring prevents panel misalignment and ensures that the door shuts and correctly seals.

IMPORTANT

Ensure the room is installed on a level surface.

If the room is being installed without a MISA floor, additional site preparation (such as floor surface preparation) should be completed prior to room installation. Freezer rooms without a MISA floor should be installed onto insulated concrete. External cold and freezer rooms are not permitted unless an approved enclosed access is provided

Ventilation & Condenser Air Extraction There must be adequate ventilation and air flow around the Freeblock refrigeration unit. Poor ventilation will void the warranty. The ambient temperature around the condenser must not exceed 43°C.

A poorly ventilated Freeblock refrigeration unit may overheat. Mechanical extraction of condenser air into ceiling space or preferably out of the building is advised.

Power Supply This appliance must be installed in accordance with the relevant electrical wiring rules and regulations (AS/NZS 3000). A suitable isolation switch (acting in all supplies) must be incorporated in the fixed supply wiring.

Refer to the rating label for power supply requirements. The rating label is located on the Freeblock refrigeration unit.

We recommend that single-phase Freeblock refrigeration units are hard wired to a 20 Amp circuit with isolation switch, and that 3-phase Freeblock units are connected to a suitable circuit as required as specified on the unit rating label.

Unpacking

The room is supplied in two packs. The first pack contains all the parts required to build the room, and the second pack contains the SKOPE supplied refrigeration unit (where applicable) (Freeblock refrigeration unit pictured). It is not necessary to unpack the refrigeration unit until the room has been built.



To unpack the room

1. Open the first pack containing the room parts. Keep the strapping and wooden cross piece as they are required to assist with removal of the refrigeration unit.
 2. Lift the door from the top of the pack. Ensure the door is kept upright to avoid potential misalignment.
 3. Remove the box from the pack. The box includes small parts.
 4. Remove the plastic film from the edge pieces.
 5. Lay the remaining parts out on the ground. Start with the edge pieces, then the wall panels, and then the ceiling and floor panels.
-

To unpack the refrigeration unit

1. Remove the cover from the crate.
-

2. Retrieve the strapping from the first pack, and thread it through the hook on top of the refrigeration unit. Tie into a secure knot to form a loop.



3. Insert the wooden cross piece into the loop and lift the Freeblock refrigeration unit from the pack.



Parts

Standard Room Parts The following parts are required for a standard room installation. Additional parts may be required.

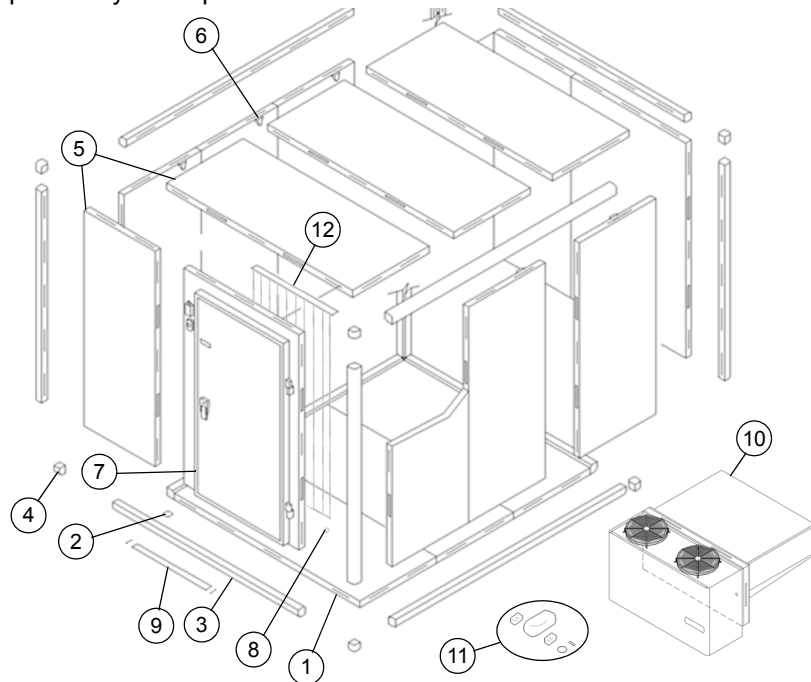

Parts list

No.	Item	Description
1	Floor panel	Grey/silver colour. Tread side up.
2	Fast fit insert	Used to align panels quickly and correctly.
3	Edge piece	Used to create right angle corners.
4	2-Way corner cap	Used to join edge pieces.
5	Wall/Ceiling panel	Standard panels are white. Available in different sizes.
6	Ceiling hanger	Used to hang ceiling on top edge pieces (on top of walls).
7	Door panel	Wall panel with door.
8	Cam lock cover	Plastic cap to cover cam lock holes. White for walls and ceiling, and silver for floor.
9	Internal ramp kit	Internal ramp used at base of door.
10	Refrigeration unit	Refrigeration unit.
11	Compliance kit	Light, light switch, external indicator and bell alarm.
-	Corner insert	Not pictured. Plastic cover for interior corners.

Additional Parts The following parts may be required in place of or in addition to the parts listed above.

Additional parts list

No.	Item	Description
12	Air curtain	Fitted behind door to minimise cool air loss during door opening.
-	U Channel	Not pictured. For use with concrete floor room.
-	U Channel corner kit	Not pictured. For use with concrete floor room.
-	Edge piece joiner kit	Not pictured. Used to join edge pieces from end to end.
-	3-Way corner kit	Not pictured. For use with multiple cell rooms.
-	Door switch	Not pictured. For use with freezer rooms.

4 Installation

Tools and Materials Required

The following tools and materials are required for a standard room installation. Additional tools and materials may be required.

Tools list

Item	Description
Cam lock tool	Used to lock panels and panel edges together.
Silicone	Used to seal floor panels and floor panel edges on all rooms, and wall and ceiling panels on cool rooms in cool low humidity areas.
Mastic	Used to seal walls and ceilings on freezer rooms. Recommended to seal walls and ceilings on cool rooms in hot humid areas.
Knife	Unpacking
Gloves	To be worn during installation

Cam Lock Tools Two cam lock tools are supplied. One is for use with the room to lock panels and panel edges together (supplied with room), and the other is used to lock the MISA Freeblock refrigeration unit into place (supplied with Freeblock refrigeration unit). Do not apply more than 1.5kg of pressure on the tools when locking the cams. Excessive pressure will damage cam locks.

IMPORTANT
Do not apply more than 1.5kg of pressure on the cam lock tool when locking the cams.

The room cam lock tool is suitable for use with 60mm panels and requires modification for use with 100mm panels. To modify the cam lock tool for use on both 60mm and 100mm panels, remove the sleeve from the pointed end of the tool.

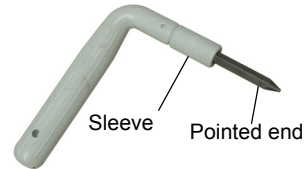

Room cam lock tool

The cam lock tool can also be used to assist with moving panels. Insert the tool into the cam holes and use the tool as a handle to lift and manoeuvre panels (see image below).



Silicone and Mastic Silicone should be used to ensure secure attachment and to keep moisture and grime from out of small gaps and spaces.

Mastic should be used in areas with high heat and humidity.

Fitting Parts Together

Panels and edge pieces are fitted together using fast-fit inserts, panel cam locks and sealant in-between panels and end pieces.

Fast-Fit Inserts Fast-fit inserts are plastic plates which slot into the edges of panels and edge pieces. One fast-fit insert should be used on every second cam lock.



Fast-fit insert



Fast-fit insert in place

Fast-fit inserts ensure correct alignment and assist with locking the panels together. As a general rule, a fast-fit insert should be used on every second slot where practical.

Panel Cam Locks Cam locks are built into floor, wall and ceiling panels. They cannot be removed or replaced.

The cams move through three stages when locking - open, closed and locked. A hook extends out from the cam when rotated, fits into the slot on the aligned room piece and pulls in to seal the two pieces together.

Do not apply more than 1.5kg of pressure on the tool when locking the cams. Excessive pressure will damage the panels.

To lock the cams

1. Align two room parts and insert the pointed tip into the cam hole on one of the parts

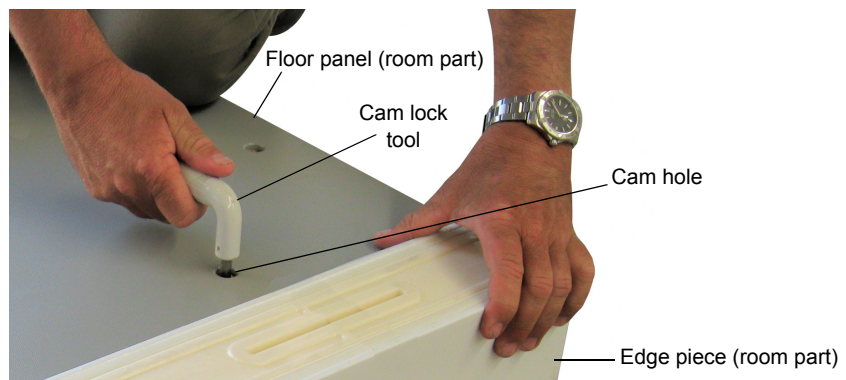

2. Rotate the tool clockwise to lock the room parts together.
-

Room Installation

The steps below detail installation of a standard four sided cool room. Before installing, ensure the site has been properly prepared. The room should be built in place, not moved into place after installation.

Ensure the room sits on a level surface. There must be no more than 5mm difference between each end of the floor. Level flooring prevents panel misalignment and ensures that the door shuts and correctly seals.

IMPORTANT

Ensure the room is installed on a level surface.

Standard MISA Floor The steps below apply to rooms with a standard MISA floor. If installing a floor-less or set-down room, refer to the steps on the next page.

To install a standard MISA floor

1. Lay the floor panels into position according to the plan. The textured tread side of the panels should face up.
-

2. Apply a bead of silicone above the top gasket rib on the side of the panel (dashed line in image) to seal gap between the floor panels.

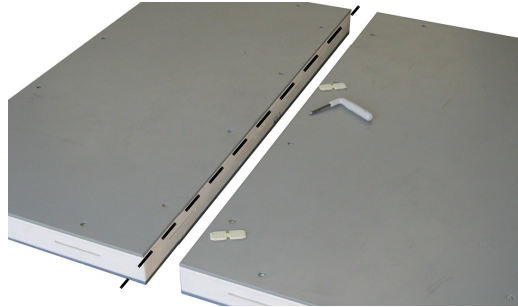

3. Align the floor panels with fast-fit inserts.
-

4. Lock the floor panels together with cam locks.

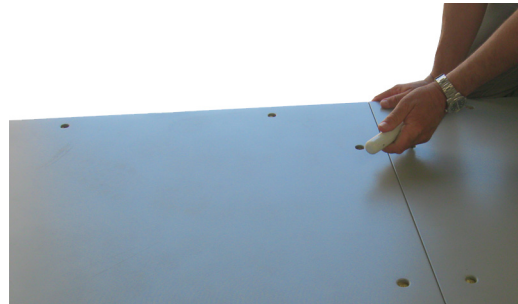

5. Check the floor is level and in the correct position.
-

6. Apply a bead of silicone approximately 20mm out from the floor perimeter (on the ground surface).

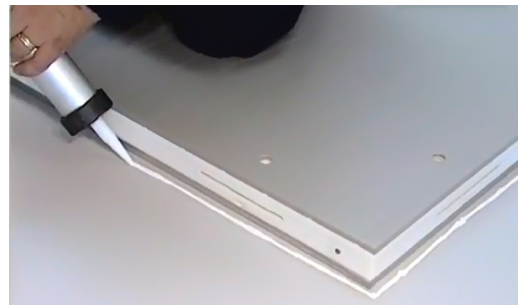

Continued over page

- Use fast-fit inserts to align the floor panel edge pieces around the floor panel perimeter (see page 13).

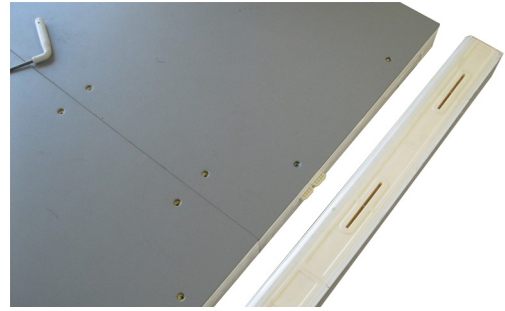

- Lock floor panel edge pieces to the floor panels with cam locks (page 13).

- Silicone and slot a 2-way corner cap into each corner of the floor. The corner cap edges slide under the floor edge pieces for a tight fit.



Floorless Room Installation

The room can be installed directly onto a concrete surface without using MISA panel flooring. U-Channels are used to support the wall panels. The U-Channel frame must be bolted in place and sealed with silicone prior to fitting the wall panels. Freezer rooms without a MISA floor must be installed onto insulated concrete.

U-Channel rooms must always be installed by a qualified technician.

IMPORTANT
Freezer rooms without a MISA floor must be installed onto insulated concrete.

Follow the steps below to install the U-Channel floor frame.

To install the U-Channel frame

- Mark out the room on floor according to plan with a chalk string line. Ensure the line is square and correct.

- Lay out the U-Channel corners as pictured.



- Lay the U-Channel lengths on the chalk line. The lengths will need to be cut on one end to fit.
- Check to make sure all sides are square. The easiest way to do this is to measure the diagonals from corner to corner, the measurements must be mm perfect.

Continued over page

5. Silicone and fix the back and sides (not the door front) of the U-Channel frame to the ground with concrete plugs.
6. Cut the front U-Channel frame piece into two pieces to allow for the door opening. To calculate the door opening size, measure the overall size of the door frame and add 24mm (12mm each side for door trim). For example, if the door is 800mm wide the cut-out opening size should be 824mm.

7. Make a 30mm x 30mm square cut to each side of the front of the U-Channel (door side) to allow the door bottom gasket seal to close on the face of the curved U-Channel.

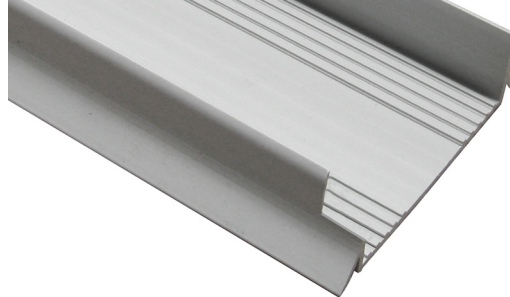

8. Silicone and fix the two front pieces of the U-Channel frame to the ground with concrete plugs.
9. The room can now be assembled. Use mastic inside the U-Channel and slot the wall panels into the U-Channel.

Walls and Ceiling

Use the supplied plan to piece together different sized wall and ceiling panels. Large rooms may require the use of roof hangers to support large ceiling spans. Refer to page 19 for information on installing roof hangers.

Due to variance of room configuration and/or the place of installation, it may be necessary to reorder these steps. For example, the ceiling may need to be moved into position prior to fitting all walls due to limited space above the room, or the door maybe fitted on a side wall rather than a front wall.

To install the walls and ceiling

1. Starting at the back wall, fit a corner wall panel and lock into place.

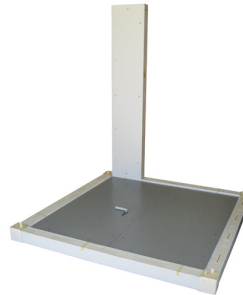

2. Fit a wall panel edge piece. Use fast-fit inserts to align and lock in place with wall panel cam locks. Ensure the top edge of the edge piece is level with the top of the wall panel.



Continued over page

3. Fit a second corner wall panel to create a right angle. Use fast-fit inserts to align and lock in place with wall panel cam locks.

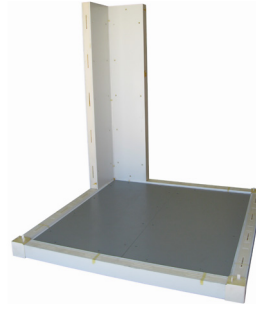

4. Continue fitting back and side wall panels, working from the back towards the front of the room. Use fast-fit inserts to align wall panels correctly and lock in place with cam locks.



Note: Rooms fitted with MISA Freeblock refrigeration unit will include a shorter panel. The refrigeration unit is installed above this panel.

5. Fit the top edge pieces on top of the back and side walls.



6. Slot the ceiling support brackets into the edges of the ceiling panel/s.



7. Lift the ceiling panel/s onto the room walls, hang using the ceiling supports and lock into place. If fitting multiple ceiling panels, fit the rear panel first and work forward.



Continued over page

-
8. Fit the front of the room. If the door panel makes up a corner, start with this. If the door panel has wall panels on either side, start from one side and work across. Do not fit the door panel last.



-
9. Fit the top edge piece/s on top of the front wall.



-
10. Slot a 2-way corner cap into each corner of the ceiling.

-
11. Fit a corner insert into each corner inside the room.



-
12. Fit the ramp inside the room at the bottom of the door frame. Drill holes as necessary and fix in place with supplied fixing screws.

-
13. If supplied, fit the air curtain to the top of the door frame.



Ceiling Hangers Rooms with large ceiling spans may require the use of ceiling hangers to support the ceiling. Ceiling hangers fit between ceiling panels and hang from either the building ceiling or from beam/s that span the cool room.

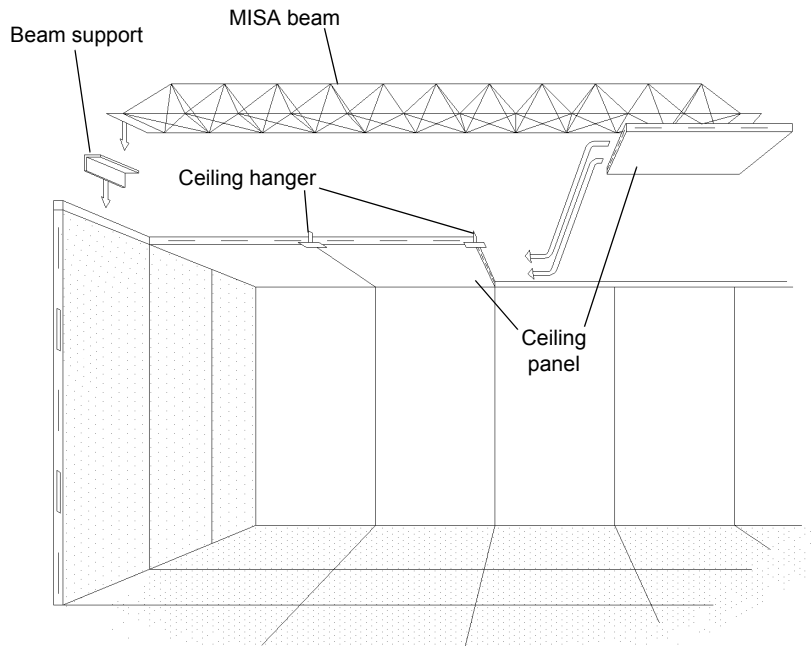
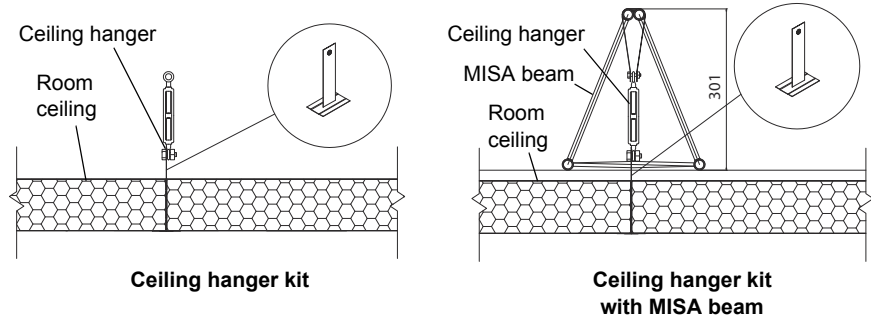

**Ceiling hanger kit installation
(shown with MISA beam)**

Freeblock Refrigeration Unit

Introduction The SKOPE MISA Freeblock side mount is a wall mounted refrigeration unit which is easily positioned and locked onto the side of the room using the supplied cam lock tool. The standard opening size for the refrigeration unit is 800mm wide x 400mm high.

The following information applies to SKOPE MISA Freeblock side mount refrigeration units. For information on SKOPE MISA Drop-In refrigeration unit installation refer to “Drop-In Refrigeration Unit” on page 31.

If the room is supplied with a third party drop-in unit or remote refrigeration system, ceiling or wall panels will need to be cut to fit the refrigeration unit. If it is necessary to cut into the panels, ensure measurements are correct before cutting and take care when cutting as the panels are delicate. Do **not** cut through cam locks. Ensure that the ceiling panels have adequate support for the refrigeration unit. If more ceiling support is required, hangers on wires attached to the cool room roof can be used. The wires can be attached to either the building internal roof beam/s. Or alternatively a strengthening beam or plate can be installed across the top of the room to support the refrigeration unit.

Refer to the documentation provided with the drop-in or remote refrigeration unit for further information.

IMPORTANT

The refrigeration unit is heavy and requires two or more people to lift.

Safety and Service When installing, using, maintaining and servicing the Freeblock refrigeration unit, follow the safety and service guidelines below:

Guidelines

- Installation must be carried out in strict compliance with the diagrams and instructions supplied by the manufacturer.
- Electrical connections must meet all relevant safety standards.
- Use safety gloves to protect your hands from cuts.
- The unit is not suitable for use in explosive environments, therefore the use of the unit in an explosion dangerous atmosphere is absolutely forbidden.
- The unit is not suitable for use in corrosive environments. In such cases protect the condenser coil and evaporator coil with appropriate means.
- Servicing must be completed by trained personnel or manufacturer according to the provisions supplied by EN378.
- When maintenance or servicing involves operations on the refrigeration circuit, empty the system and allow it to reach atmospheric pressure.
- Do not discharge the refrigerant gas into the atmosphere. Refrigerant gas must always be recovered by specialised technicians using suitable equipment.
- Quantity and quality of the refrigerant charge are indicated on the data plate.
- Do not use alternative refrigerants (especially inflammable fluids e.g. hydrocarbons) or air.
- Do not modify or alter the refrigerating circuit or its components.
- The unit shall only be used following the instructions indicated by the supplier. Any incorrect use can result in damage to the unit and represents a serious danger for peoples health.

- The user shall protect the system from external fire hazards.
- If the unit is fitted with a light, the light must be disconnected or removed. Refer to “Compliance Kit” on page 25 for room lighting requirements.
- The user is strongly recommended to contact the manufacturer before attempting any intervention on the unit and any use not corresponding to the manufacturers directions (in particular the field of application). Please enquire about the possible dangers connected with improper use of the unit.

Note: Damages due to improper connections void any warranties.

Drainage Although the unit has its own condensation tray, high heat and humidity may cause the tray to overflow. To compensate for this the Freeblock refrigeration unit must be installed with a drain connection to a waste outlet.

Ventilation & Condenser Air Extraction There must be adequate ventilation and/or extraction for air flow around the Freeblock refrigeration unit. Poor ventilation will void the warranty. The ambient temperature around the condenser must not exceed 43°C.

A poorly ventilated Freeblock refrigeration unit may overheat. Mechanical extraction of condenser air into ceiling space or preferably out of the building is advised.

Power Supply We recommend that single-phase Freeblock refrigeration units are hard wired to a 20 Amp circuit with isolation switch, and that 3-phase Freeblock units are connected to a suitable circuit as required as specified on the unit rating label. Refer to “Electrics” on page 25 for more information.

Refer to the rating label for power supply requirements. The rating label is located either on the cabinet interior or on the Freeblock refrigeration unit.

Installation Follow the steps below to install the Freeblock refrigeration unit.

To install the refrigeration unit

1. Carefully lift the refrigeration unit up and insert the evaporator into the wall space. Access can be made easier by lifting the ceiling corner above the refrigeration unit space.



2. Ensure the refrigeration unit is fully inserted and flush with the interior wall surface.
-

3. Use the large cam lock tool to lock the refrigeration unit into position.

Remove the front panel from the refrigeration unit to access the top cam locks. The bottom cam locks are accessed from inside the room.



-
4. Refit the front cover.
 5. Connect up the electrical components (see page 25), complete the room inspection (see page 27) and installation checklist (see back page).
-

Main Switch The Freeblock refrigeration unit may be fitted with a main switch on top of the Freeblock condenser. The switch lights up green when switched on.
Note: This switch is not the mains isolation switch. A dedicated isolation switch must be included in the installation (see “Power Supply” on page 21).

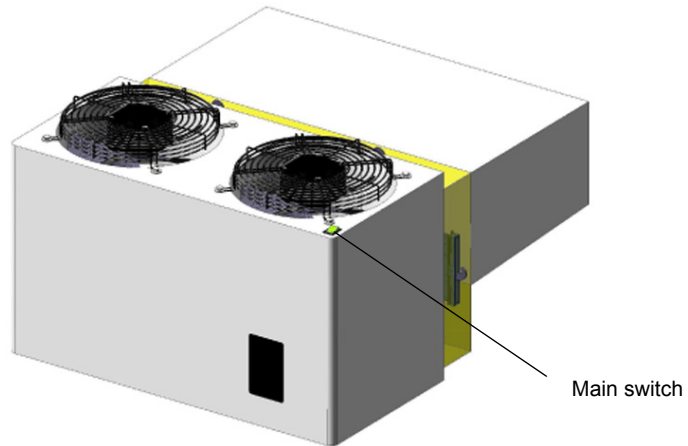

Freeblock Control Panel

Depending on the date of manufacture, the Freeblock refrigeration unit will be fitted with an Eliwell control panel or a Touch Instrument control panel, visible on the front of the Freeblock condenser. It displays the internal cabinet temperature, and signals temperature and equipment alarms.

Refer to the Eliwell or Touch Instrument sections below and over page for an overview of the control panel and instructions on changing the set-point, and documentation supplied with the refrigeration unit for further information.

Eliwell Control Panel Refer to the diagram and table below for button identification.

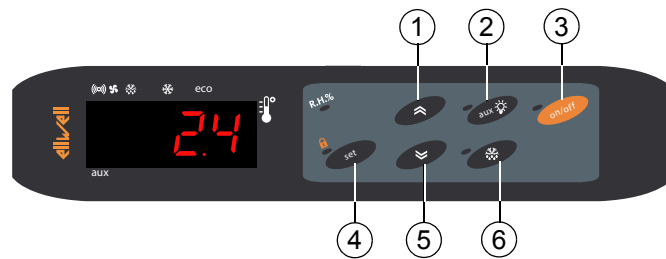

Item	Icon	Function
1		Up button: Used for programming.
2		Aux button: Used for programming. Note: This button must not be used as a light switch.
3		On/Off button: Press to put the refrigeration into and out of standby. Note: When in standby the interior light still functions as normal.
4		Set button: Used for programming. Press and hold for five seconds to initiate a manual defrost.
5		Down button: Used for programming.
6		Defrost button: Press to turn the interior light on and off.

Touch Instrument Control Panel

Refer to the diagram and table below for button identification.

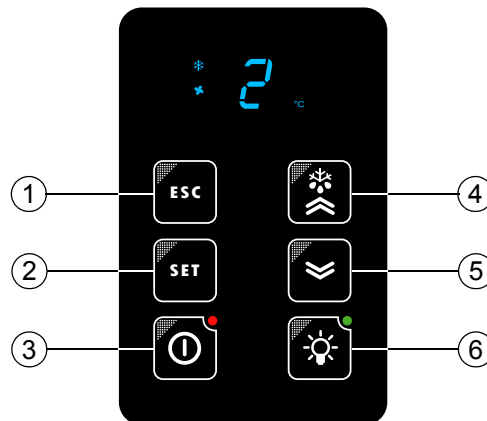

Item	Icon	Function
1		Escape button: Used for programming.
2		Set button: Used for programming.
3		On/Off button: Press to put the refrigeration into and out of standby. Note: When in standby the interior light still functions as normal.
4		Up/Defrost button: Used for programming. Press and hold for five seconds to initiate a manual defrost.
5		Down button: Used for programming.
6		Light button: Not applicable. Note: This button must not be used as a light switch.

Set-Point Follow the instructions below to view and change the operating temperature set-point. Refer to “Specifications” on page 4 for temperature ranges.

To view the operating temperature set-point

1. Press and release the set button, ‘set’ will show on the display.
2. While ‘set’ is displayed, press the set button again to display the set-point value.

To change the operating temperature set-point

1. Follow the procedure above to view the set-point.
2. While the set-point is displayed, use the up and down buttons to change the set-point.

Electrics

All electrical wiring should be completed by a licenced electrician and installed in accordance with the relevant electrical wiring rules and regulations (AS/NZS 3000).

Compliance Kit A compliance kit is supplied with the room and must be fitted. The kit for a standard room includes a light, a light switch, an external indicator and a bell alarm. In addition to the items mentioned above, combo rooms with internal access doors are also supplied with an electronic man in room (MIR) alarm, and additional lighting and external indicators as required.

Australian standards require the light and light switch to be fitted inside the room, and the external indicator fitted outside the room. The external indicator illuminates when the light is on.

The light should be mounted inside the room (typically on the ceiling), the light switch should be mounted inside the room next to the door, and the external indicator should be mounted beside the door on the outside of the room.

The alarm bell must be fitted to the door (follow instructions included with the bell). Combo rooms must have the MIR alarm fitted to the room with internal access (follow instructions included with the MIR alarm).

The compliance kit must be wired up by a licenced electrician (see diagrams below).

Note: If the unit is fitted with a light, the unit light must be disconnected or removed. The compliance kit light switch must be the only available light switch for the room.

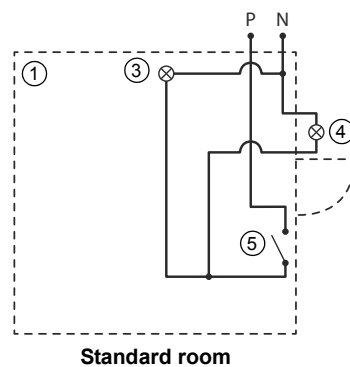

Legend

No.	Description
1	Room with external door
2	Room with internal door
3	Light
4	External indicator
5	Light switch
6	Electronic MIR alarm

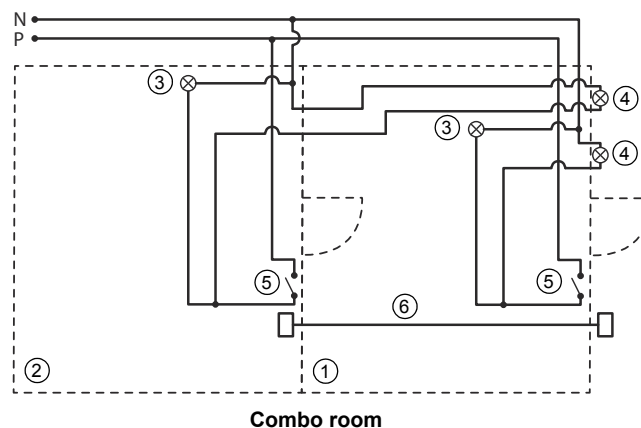

Refrigeration Unit Wiring Once the room has been assembled and the unit fitted, the refrigeration unit electrical wiring can be connected.

Two electrical cables exit the top of the refrigeration unit. One of these is the mains supply cable, and the other is the door switch cable.

The mains supply cable is made up of active, neutral and earth wires. We recommend that single-phase Freeblock refrigeration units are hard wired to a 20 Amp circuit with isolation switch, and that 3-phase Freeblock units are connected to a suitable circuit as required as specified on the unit rating label.

The door switch cable is wired up to a door switch located above the door (see “Door Switch” on page 27).

Door Heater Wiring The door heater wires are located in the door panel around the door opening, and can be accessed by prying off the edge of the door opening beside the door heater electrical box.

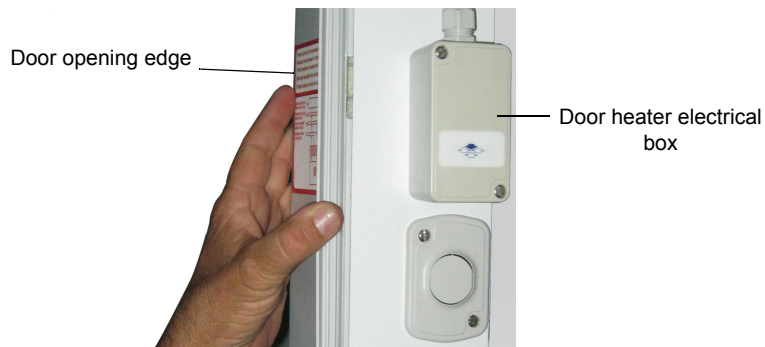

The door heater must be connected up to a separate circuit. Refer to the diagram below for door heater wiring details.

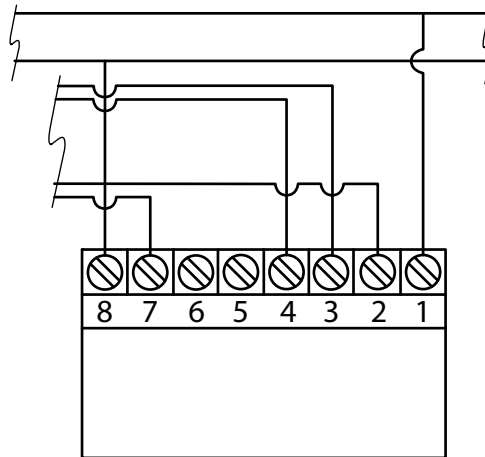

Legend

No.	Description
1 & 8	Power supply - 230 V.a.c. on separate circuit
3 & 4	Heater valve - Expansion valve
5 & 6	Remote contact - Do NOT connect up
2 & 7	Door heater - Heater element that runs around the door frame

Door Switch

The door switch must be fitted to freezer rooms and is optional on cool rooms. When fitted, the door switch turns the lights on and the evaporator fan off when the door is opened, and the lights off and evaporator fan on when the door is closed.

Freeblock refrigeration units are fitted with a door switch cable to connect the door switch. If a door switch is not being used the door switch cable should be removed.

Follow the swing door procedure (below) or sliding door procedure (page 29) to fit the door switch.

Swing Door Follow the procedure below to install the swing door switch.

Parts required

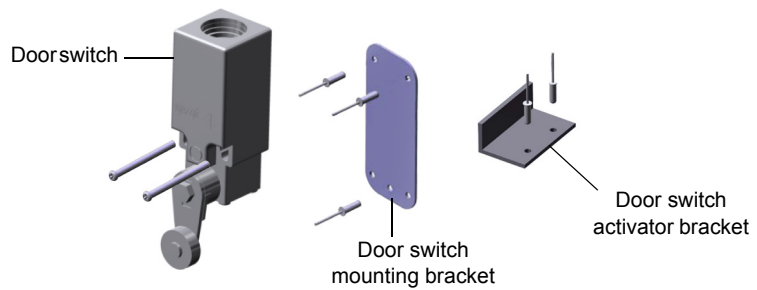

To install the swing door switch and activator bracket

1. Unscrew the door switch arm and rotate 90° anti-clockwise as pictured. Reattach.

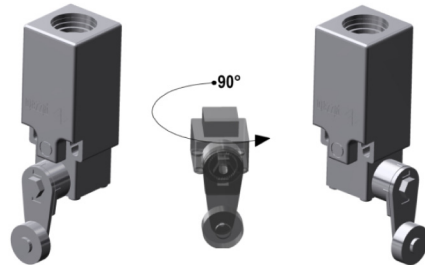

2. Loosen the lever bolt and rotate the lever out 50° as pictured.



Continued over page

3. Fit the door switch activator bracket to the top edge of the door, 10mm in from the inside face of the door as pictured. Drill and fix in place with two 3.2x8 rivets (supplied).

4. Fit the door switch mounting bracket above the door as pictured, drill and fix in place with three 3.2 x 8 rivets (supplied).

5. Drill two 2.5mm holes through the existing holes in the door switch bracket, and fit the door switch to the door switch bracket. Fix in place with the two 3.8 x 45 fixing screws (supplied).

6. Open and close the door and ensure the door switch activator activates the door switch lever.

7. Remove the door switch cover by loosening the anchoring screw, and use a 2 x 1.5mm cable to connect the door switch to the refrigeration unit electronic controller. **Note:** Free block refrigeration units are supplied with a door switch cable, just connect the cable to the door switch connector block.

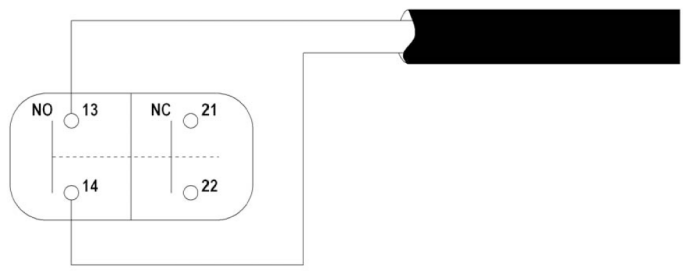

Sliding Door Follow the procedure below to install the sliding door switch.

Parts required

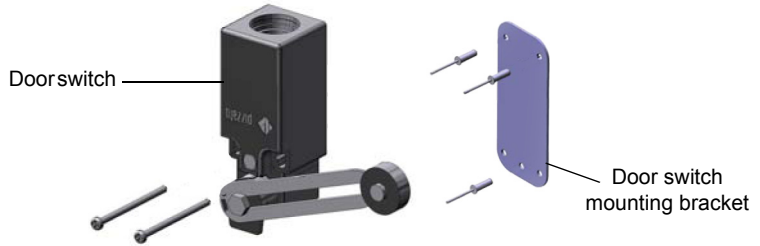

To install the sliding door switch and activator bracket

1. Unscrew the door switch arm and rotate 20° up as pictured.

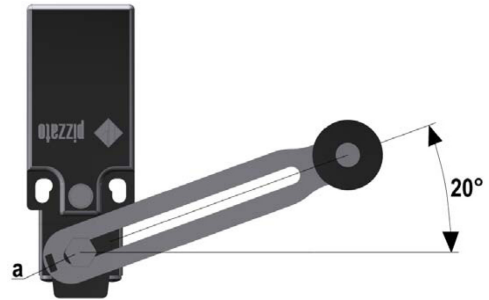

2. Fit the door switch mounting bracket to the handle side door frame as pictured. Drill and fix in place with three 3.2 × 8 rivets (supplied).

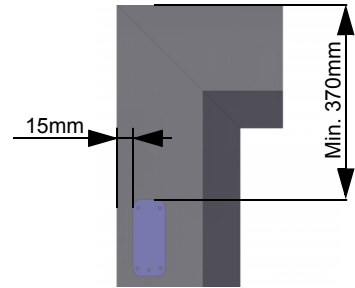

3. Drill two 2.5mm holes through the existing holes in the door switch bracket, and fit the door switch to the door switch bracket. Fix in place with two 3.8 × 45 fixing screws (supplied)

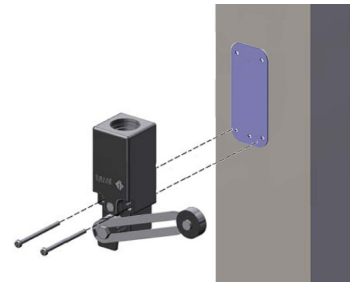

4. Remove the door switch cover by loosening the anchoring screw, and use a 2 × 1.5mm cable to connect the door switch to the refrigeration unit electronic controller. **Note:** Free block refrigeration units are supplied with a door switch cable, just connect the cable to the door switch connector block.

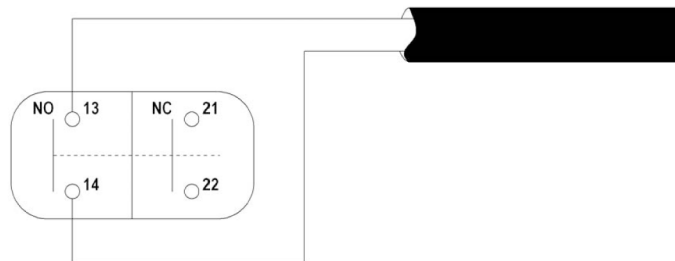

Room Inspection

Once the room has been assembled and the refrigeration unit fitted, inspect that the room is assembled correctly by shutting yourself inside the room. If no light filters through, the room is assembled correctly. If light does filter through, realign the panels to seal any gaps, and check that the door is correctly fitted (see page 32 for door servicing).

After checking that the room is assembled correctly, fit the plastic caps over the cam lock holes. The white caps are for the walls and the silver caps are for the floor.

Drop-In Refrigeration Unit

The following information applies to SKOPE MISA Drop-In refrigeration units. For information on SKOPE MISA Freeblock refrigeration unit installation refer to “Freeblock Refrigeration Unit” on page 20. If the room is supplied with a third party drop-in unit or remote refrigeration system, refer to the documentation provided with the drop-in or remote refrigeration unit for further information.

Safety When installing, using, maintaining or servicing the Drop-In refrigeration unit, follow the safety and service guidelines on page 18.

Installation The SKOPE MISA Drop-In refrigeration unit is designed to be located on top of the cool/freezer room. Follow the instructions supplied with the Drop-In refrigeration unit. Once installed, have the Drop-In refrigeration unit commissioned by a licenced technician before initial start-up.

Drainage Although the unit has its own condensation tray, high heat and humidity may cause the tray to overflow. To compensate for this the Drop-In refrigeration unit must be installed with a drain connection to a waste outlet.

Ventilation There must be adequate ventilation and airflow around the Drop-In refrigeration unit. Poor ventilation will void the warranty. The unit condensing temperature must not exceed 45°C. If adequate airflow is not available, mechanical air extraction must be used. Mechanical extraction of condenser air into ceiling space or preferably out of the building is advised.

Enclosures If the Drop-In refrigeration unit is enclosed, the enclosure must have an air intake grille and the ceiling above must have adequate extraction to the outside of the building. This must be in place prior to room installation and should be done based on the installer recommendations. This work is not the responsibility of SKOPE or the SKOPE approved installer.

Power Supply We recommend that single-phase Freeblock refrigeration units are hard wired to a 20 Amp circuit with isolation switch, and that 3-phase Freeblock units are connected to a suitable circuit as required as specified on the unit rating label. Refer to “Electrics” on page 25 for more information.

Refer to the rating label for power supply requirements. The rating label is located either on the cabinet interior or on the Freeblock refrigeration unit.

Controller The electronic controller control panel should be located beside the room door.

Lighting If the unit is fitted with a light, the light must be disconnected or removed. Refer to “Compliance Kit” on page 25 for room lighting requirements.

5 Servicing

Cleaning

Room Periodically wipe the inside and outside of the room with a damp cloth. Use neutral or slightly alkaline detergent, and rinse and dry the panels after cleaning. Isolate the refrigeration unit from the power supply when cleaning around electrical components.

Condenser Coil To ensure trouble-free performance, the condenser coil must be kept clean. We strongly urge monthly cleaning with a soft brush to remove dust and fluff, and a thorough cleaning every six months. The condenser coil must be kept clean for efficient and reliable operation. Always isolate the refrigeration unit from the power supply when cleaning the condenser coil.

Door

Door Seal To ensure the room operates correctly and efficiently, the door must close and seal correctly. To check this, enter the room and shut the door. No light should filter around the door opening. If light is filtering through, check the door and gasket for alignment and adjust as necessary (see Door Alignment and Door lock & Gasket Alignment below).

Door Alignment If a door is out of alignment, follow the steps below to realign it.
To realign the door

1. Open the door and remove the top door hinge cover.

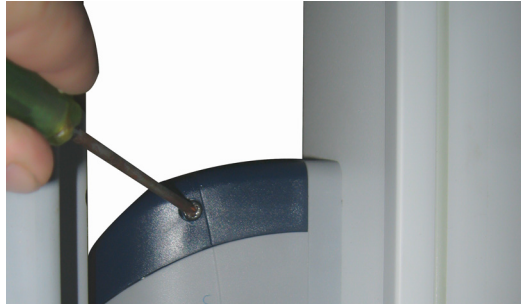

2. Close the door and loosen the two adjustment screws.



3. Move the top of the door left or right as necessary to align correctly.
4. Once the door is correctly aligned, tighten the two adjustment screws and refit the door hinge cover.

Door Lock & Gasket Alignment The door lock can be adjusted to ensure the door closes and gasket seals on the door opening. If the gasket is not sealing correctly, follow the steps below to adjust the door lock as necessary.

To realign the gasket

1. Open the door and use a small screwdriver to unclip and remove the door handle cover from the inside of the door.



2. Loosen the two adjustment screws.



3. Move the lock section of the handle in or out as necessary to align correctly.
4. Once the door is correctly aligned, tighten the two adjustment screws and refit the door lock cover.

Door Heater Wire The door heater wire runs around the perimeter of the door opening. Refer to page 26 for wiring information. Follow the steps below to access the door heater wire.

To access the door heater wire

1. Ensure the refrigeration unit is isolated from the power supply.
2. Open the door.
3. Remove the door heater electrical box to access the heater wire terminals.

4. Pry the edge of the door opening off to access the heater wire.



MISA Installation and Commissioning Checklist

The following checklist must be completed on-site by the installer after the room has been installed. A completed copy must stay on site and a copy sent to SKOPE for warranty registration - warranty@skopeco.nz. If this checklist cannot be completed due to installation issues, please contact SKOPE as soon as possible.

Site Details

Approved installer: _____

Customer's name: _____

Address of installation: _____

Date of installation: _____

MISA serial number (located on the door): _____

Description of work: _____

Compliance

The installation has been completed in accordance with:

- the MISA installation manual
- the customer's plans and specifications
- the terms of local authority consents
- all relevant laws, regulations, building codes and standards

Construction

Tick to indicate the following key installation details have been adhered to:

- There is adequate ventilation and airflow around the refrigeration unit.
- If adequate airflow is not available, a suitable heat extractor has been installed.
- The room has been installed on a flat and level concrete surface as per the installation manual.
- Room inspection has been performed.
- The supplied roof supports have been used to support the room roof.

Operation

Tick to indicate everything is operating correctly:

- Airflow is unimpeded on the inside and outside of the room.
- The refrigeration unit is operating correctly.
- The door is sealing correctly (adjust door if necessary).
- Heater element/s are operating correctly (freezer rooms only).

Please record the following information and tick the boxes once installation has been completed and the room powered up for the first time. Note: Any issues or irregularities must be investigated and rectified to specifications. Ambient air on (air onto condenser) must not exceed 43°C.

The ambient air on temperature at condenser - _____ when first powered up: _____

after 15 minutes: _____

after 30 minutes: _____

after 60 minutes: _____

Unit current draw (Amps): _____

Power supply: 240V single phase 415V three phase

