

## GELATO SHOWCASE

### FEATURES

#### • MODERN DESIGN

By harmonizing curvature and rigidity, our modern style product designs are user-friendly while maintaining the highest product visibility and aesthetics.

#### • AUTOMATIC DEFROSTING SYSTEM

The automatic defrost cycle on/off periodically, melting the ice that would otherwise build up in the Gelato Case's interior for less maintenance and better hygiene.

#### • DOUBLE GLAZED FRONT & SIDE GLASSES

Double glazed windows are an ideal energy efficient choice as an added layer of insulation which reduces the amount of cold air escaping. It also prevents condensation for better product presentation at all times.

#### • DOUBLE EVAPORATOR FOR GREATER TEMPERATURE DISTRIBUTION

SKIPIO's Gelato Case is designed with oversized and balanced refrigeration systems. These include 2 efficient evaporators and a large condenser for faster cooling and greater efficiency.

#### • LED SPOT LIGHT TOP PANEL

The presentation of displayed products are enhanced through LED lighting and also it reduces unnecessary energy consumption.

#### • DIGITAL TEMPERATURE CONTROL SYSTEM

It provides precise and constant temperature. This level of precision allows the displayed foods to remain fresh over an extended period of time.

SGC-1500F



(BLACK)



#### Sydney Branch

ADD: 218 Woodpark Road Smithfield NSW 2164  
TEL: +61 2 8798 3061 / 5283 / 5581  
X: +61 2 8798 5707  
EMAIL: admin@skipio-australia.com

#### Melbourne Branch

ADD: 55 Lara Way Campbellfield VIC 3061  
TEL: +61 3 8405 3359 / 9408 - 4081  
X: +61 3 9408 9384  
EMAIL: adminvic@skipio-australia.com

#### Brisbane Branch

ADD: 3/74 Murdoch Circuit, Acacia Ridge 4110 QLD  
TEL: +61 7 3155 0250  
EMAIL: adminqld@skipio-australia.com



www.skipio.com.au

## GELATO SHOWCASE

MODEL	SGC-1500F
Classification	Freezer
Cabinet Dimension (WxDxH mm)	1547 x 1100x 1321
Inner Temperature(°C)	-25°C~-15°C
Refrigent	R-404A
Insulation Type	Polyurethane/ Cyclopentane + CFC Free
Amps(A)	12A
Power(W)	440W
Voltage(V/Hz/Ph)	240V / 50Hz / 1PH
Weight(Kg)	260Kg
Door type	Sliding Doors
Power plug	15A

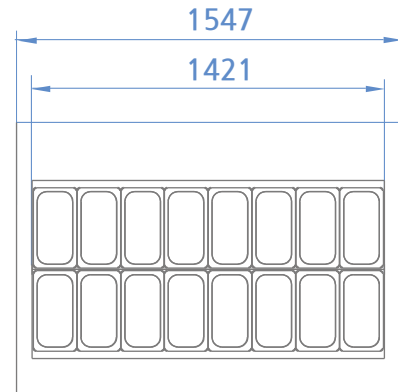

TOP VIEW

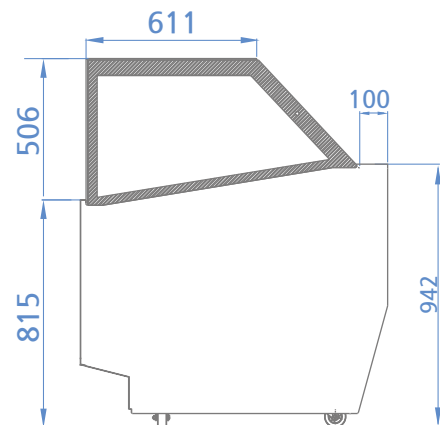

SIDE VIEW

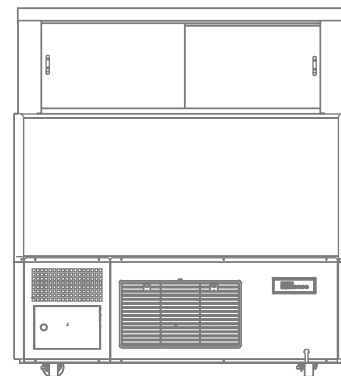

BACK VIEW

\* GELATO TUB (Standard : SGC-1200F MODEL) H : 150

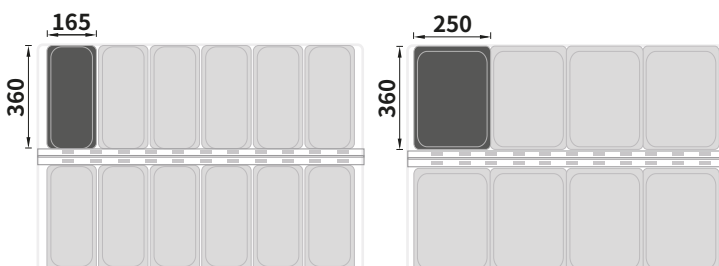

Sydney Branch  
 ADD: 218 Woodpark Road Smithfield NSW 2164  
 TEL: +61 2 8798 5061 / 5283 / 5581  
 X: +61 2 8798 5707  
 EMAIL: admin@skipio-australia.com

Melbourne Branch  
 ADD: 55 Lara Way Campbellfield VIC 3061  
 TEL: +61 3 8405 3359 / 9408 - 4081  
 X: +61 3 9408 9384  
 EMAIL: adminvic@skipio-australia.com

Brisbane Branch  
 ADD: 3/74 Murdoch Circuit, Acacia Ridge 4110 QLD  
 TEL: +61 7 3155 0250  
 EMAIL: adminqld@skipio-australia.com

